

Vinyl Real Glass Block Windows

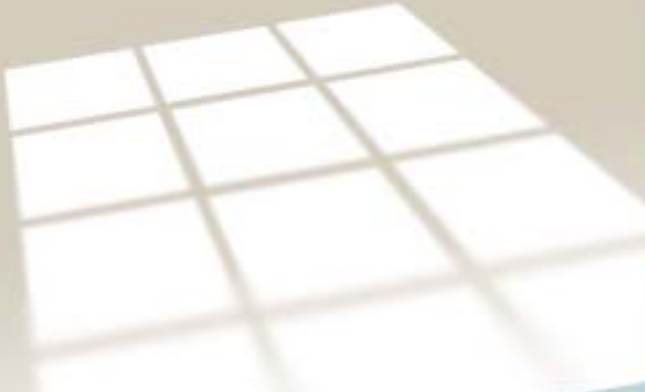

Voted
**Highest
Quality**



by the National Association of
Home Builders Survey and
Builder Magazine

Real Glass and Performance in a sleek new package

*Why have a plastic block window, when you can have the beauty and brilliance of real glass block in a light, easy to install package. Demand Vinyl Wrap® **real** glass block windows!*



2 INCH STOCK SERIES

(30% Lighter and Thinner)

FRAME COLORS • White • Almond

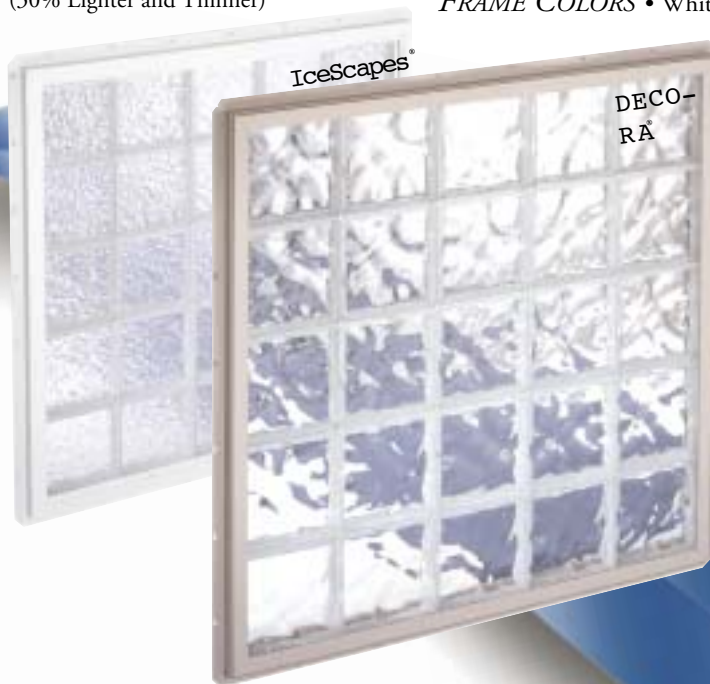

Block Unit Sizes Available

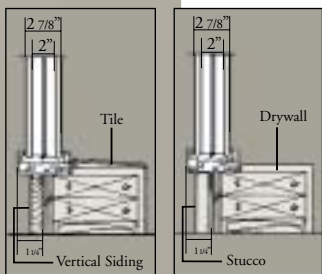
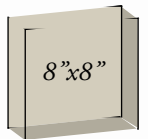

Our sleek new vinyl window profile gives you more glass and less frame.

Our goals are simple. We simply want to exceed your expectations.

- *Privacy • Quality • Durability • Maximum Natural Light*
- *Ease of Maintenance • Easy Installation*
- *Beauty of REAL GLASS BLOCK*



3 INCH CUSTOM SERIES

Block Unit Sizes Available

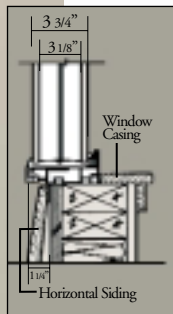
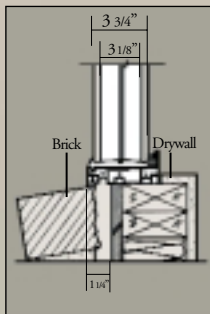
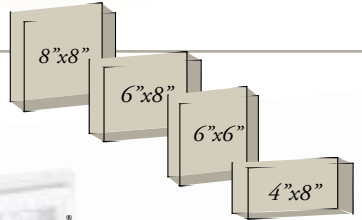

RETROFITTING

Made easy by combining different size blocks that adjust to almost any size opening



4 INCH CUSTOM SERIES

Block Unit Sizes Available

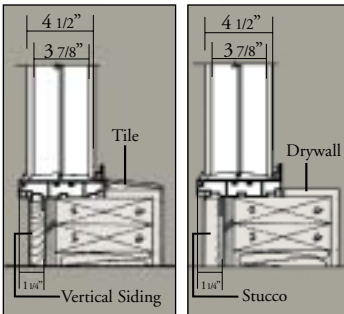
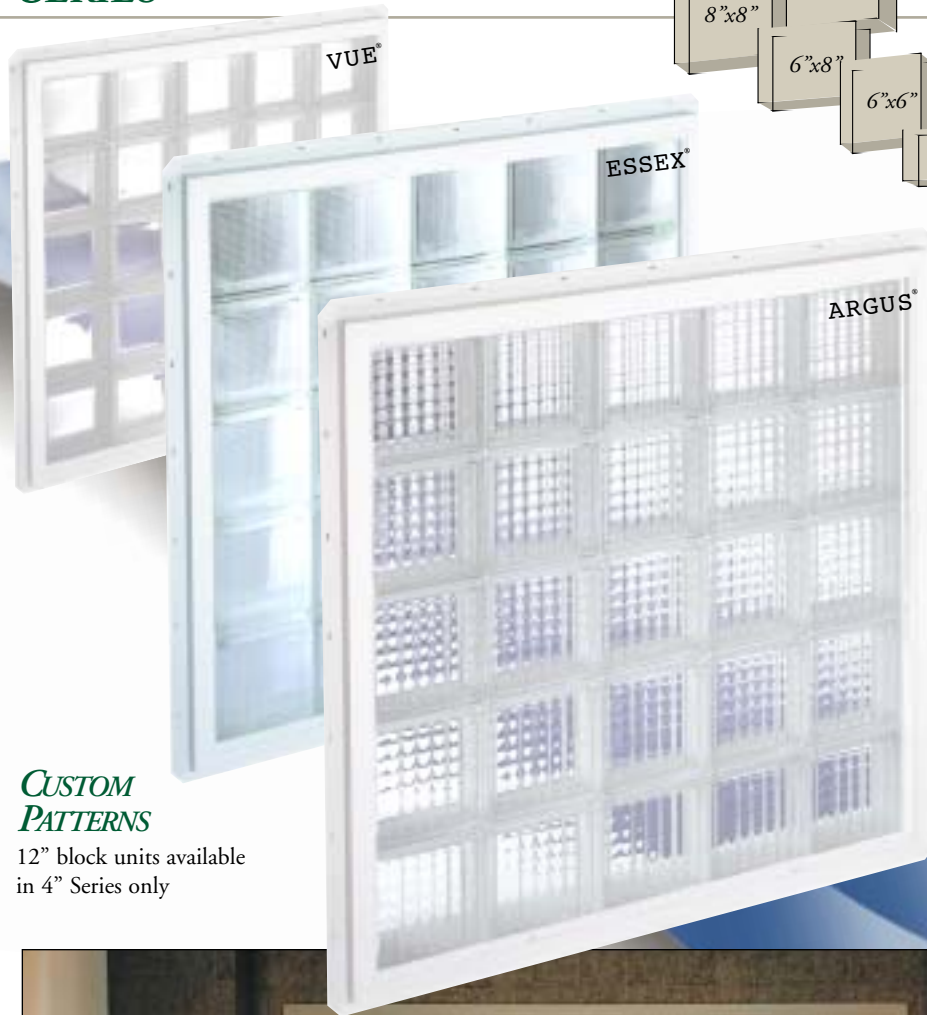
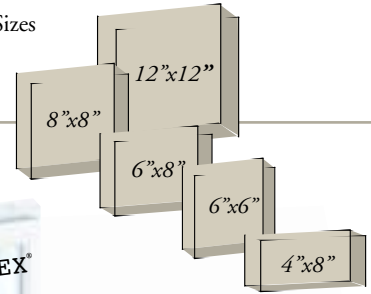

CUSTOM PATTERNS

12" block units available in 4" Series only



FRESH AIR SLIDERS

Check with local manufacturer for availability

Top off that tub window with a Fresh Air Slider available in clear or obscure glass. Some limitations apply call for availability.



STAIR STEP SHAPES

Check with local manufacturer for availability

Customize your window design with Stair Step window shapes or mixed patterns and block sizes



CUSTOM COLOR VINYL COATINGS

A wide variety of custom colors available

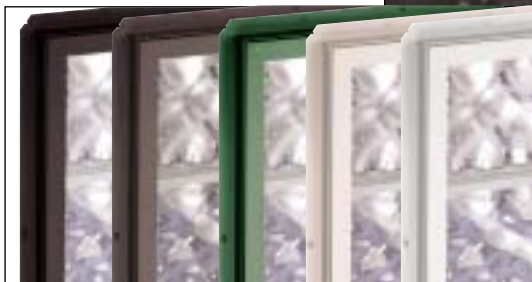



P E R F O R M A N C E

F O R A L I F E T I M E



THERMAL PERFORMANCE Heat & Cold
Thermal efficiency test varied upon block thickness from .42 up to .52. Test standard: NFRC

IMPACT
400 Foot pound testing resulted in no damage
Test Standard: CPSC 16 CFR 1201 Category

WATER INFILTRATION
Performance after structural test @ 7.5 psf resulted in no infiltration.
Test Standard: ASTM & 547-96

FORCED ENTRY
Several forced entry attempts results in no window failure
Test standard: CMBSO / CAWM301-90, forced entry resistance

WIND LOAD Hurricane
3" System tested up to 322 mile per hour winds.
Test Standard: AAMA / NWDA 101/I.S. 2-97

MISSILE IMPACT 8' long 2 x 4 test
Large missile impact and coastal structure loads are achieved with 4" system only using thick-set Glass Block units

*All vinyl wrap systems are TDI approved for inland zone 1 and 2



ENGINEERED

by a team of fenestration experts to withstand the most extreme of conditions. Our patented vinyl stack spacing® system outperforms other real glass block windows that have no integral spacer and rely only on a thin bead of silicone to assemble and seal between glass blocks.



Glass block pattern names are property of Pittsburgh Corning Corporation.

	2" System	3" System	4" System
Thermal R-Value	1.92	2.13	2.38
Thermal U-Value	.52	.47	.42
Sound Transmission	26	31	39
Safety 400lb Impact	passed	passed	passed
Wind Load pounds per square foot	75psf	260psf	260psf
Weight per square foot	9.8	13.	17.

Rough Opening Chart

Based on Using 8" x 8" Glass Block Units

Stock 2" Thick

Custom 3" & 4" Thick

Number of Blocks Rough Opening

Number of Blocks Rough Opening

1	10"
2	17 3/4"
3	25 3/4"
4	33 1/2"
5	41 1/4"
6	49 1/4"
7	57"
8	65"
9	72 3/4"
10	80 3/4"

1	10 1/2"
2	18"
3	26"
4	33 3/4"
5	41 3/4"
6	49 1/2"
7	57 1/2"
8	65 1/4"
9	73 1/4"
10	81"

LOCAL DEALER

Vinyl Wrap® and Vinyl Stack® Patent and Trademarks owned and developed by Seattle Glass Block
1-800-829-9419 www.seattleglassblock.com

10 YEAR LIMITED WARRANTY

Vinyl Wrap Glass Block windows are guaranteed and warranted by independent fabricators for a period of 10 years - to be free from defect in materials, workmanship and performance. Limitations and conditions available upon request.